



**Contact Information**

Company	Project
Name, first name	Tel.
Email	

**Parent roll**

min. web width $B_{min}$	in.	max. web width $B_{max}$	in.
min. material tension	lbf	max. material tension	lbf
min. tension per in. web width	lbf/in.	max. tension per in. web width	lbf/in.
material		material speed	ft./Min

**Measuring roller**

Insta. dim., overall length $L_G$	in.	effective roller width $B_M$	in.
segment width $B_{Seg}$	in.	custom. segment width $B_{Seg}$	in.

**Dimensions**

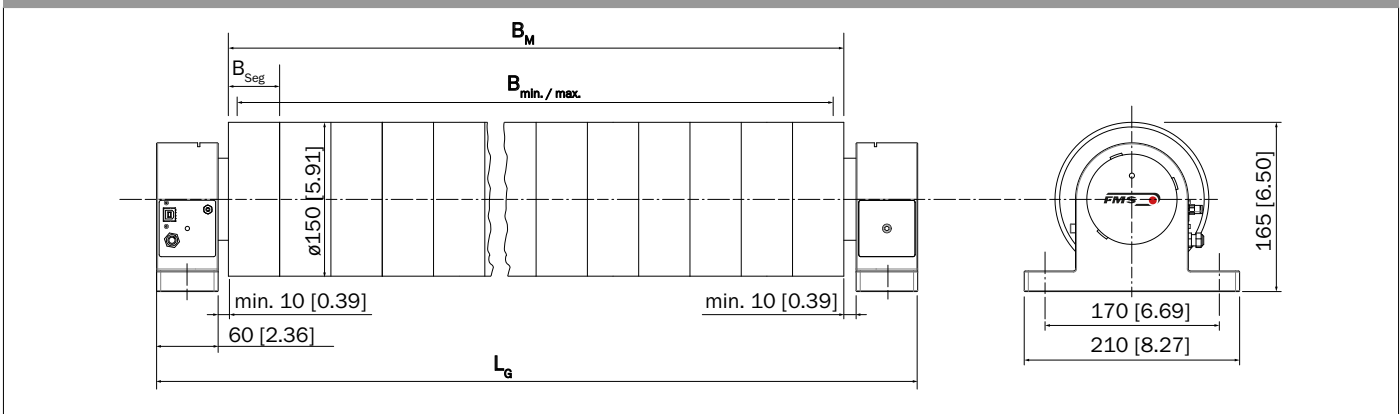

**Web path**

wrap angle $\alpha$	°	entry angle $\beta$	°
exit angle $\gamma$	°		

**Installation** (Please provide a sketch of the web path including entry and exit angle, if possible.)

Example

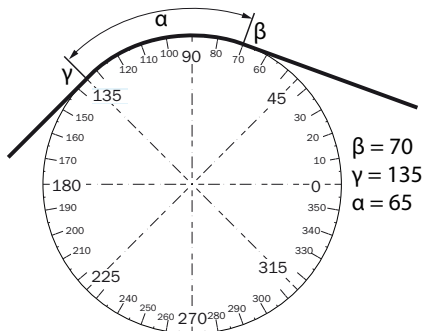

Your sketch

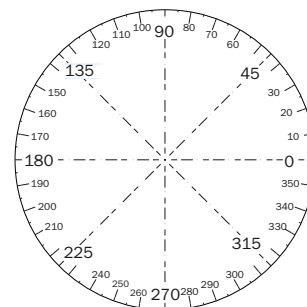

**Related Products**

Data display	Gateway	Cables	Connectors	Nuts & Bolts
--------------	---------	--------	------------	--------------

**Contact Information**

Company	Project
Name, first name	Tel.
Email	

**Bracket type P „pillow block“: Orientation**

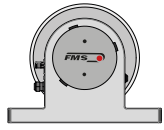
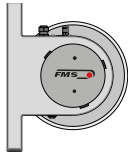
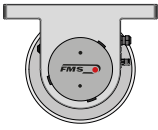
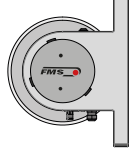
			
PS - South	PW - West	PN - North	PO - East

**Connector side**

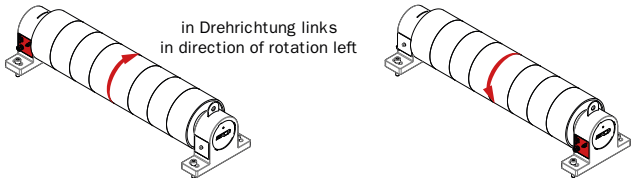
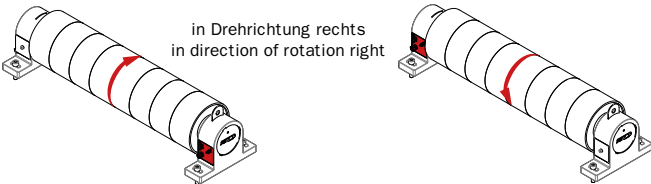
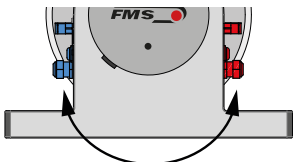
Connectors left (dir. of rot. red arrow)	Connectors right (dir. of rot. red arrow)
 <p>in Drehrichtung links in direction of rotation left</p>	 <p>in Drehrichtung rechts in direction of rotation right</p>
<p>The connection side is independent of the orientation of the brackets</p>	
<p>Depending on the wrap angle, the connections can also be opposite the position shown above. (blue or red position in the picture on the right).</p>	

**Measuring roller**

roller material	roller surface
-----------------	----------------